

Indian Linux Users' Group, Chennai (ILUGC)

in association with

**Thiagarajar College of Engineering, Madurai**

presents

---

---

# Free Software for Engineers

---

---

by

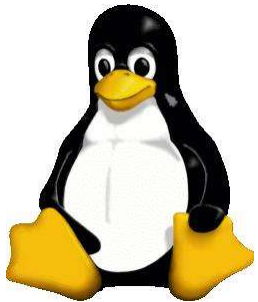

**Shakthi Kannan** MS



**Thiagarajar College of Engineering, Madurai**



# GNU/Linux Programming

---



- **C**
- **C++**
- **Assembly**
- **Java**
- **Bash scripting**
- **Perl**
- **Python**
- **GUI Programming (GTK / Qt)**
- **Tcl/Tk**

# GNU/Linux IDE/Text Editors

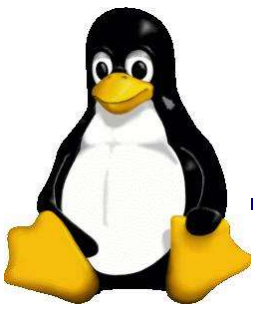

- Eclipse
- Anjuta
- KDevelop
- DrPython
- vi/vim
- GNU Emacs
- Pico / Nano
- Kate
- Kwrite
- gedit

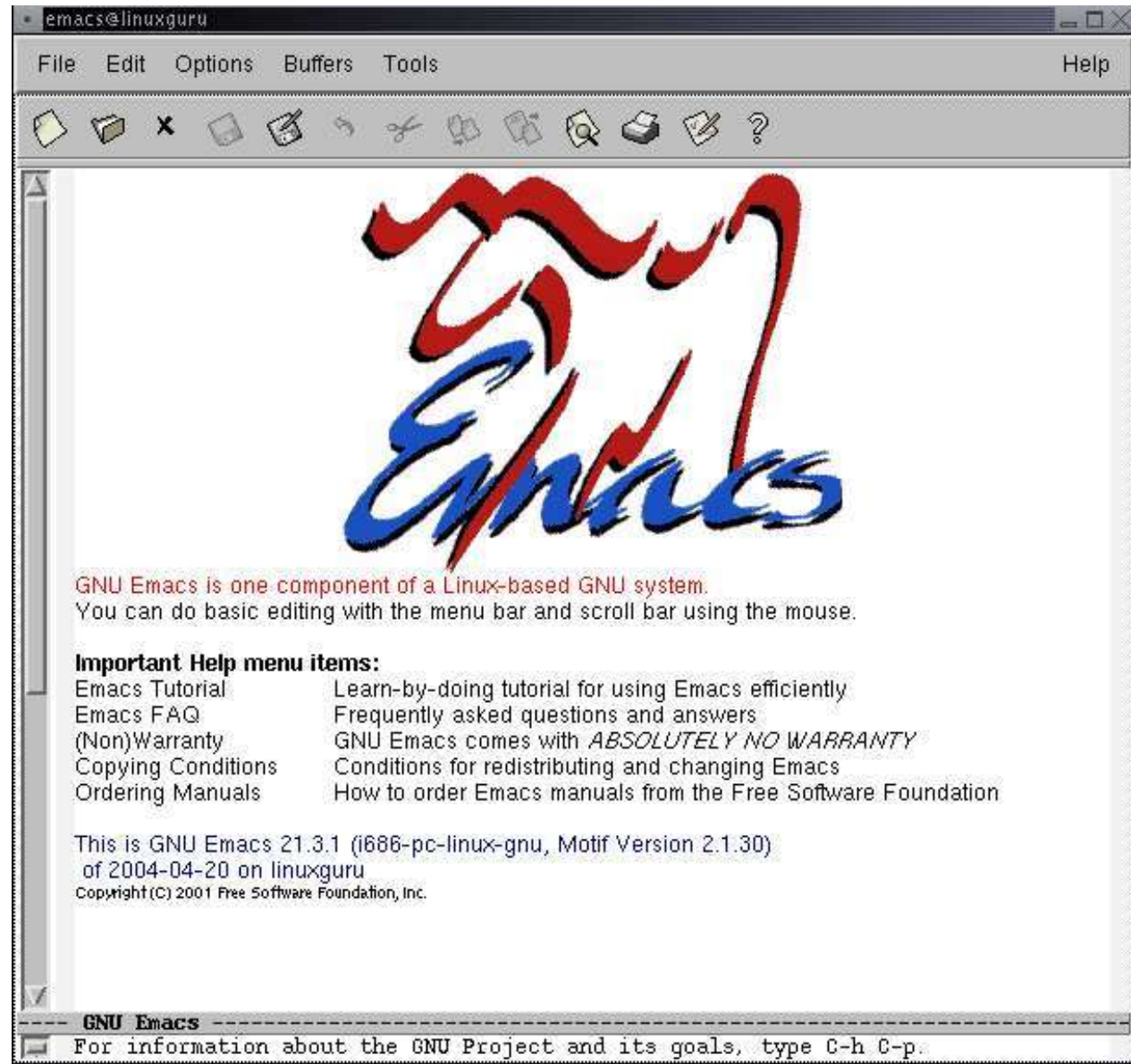

# Eclipse IDE

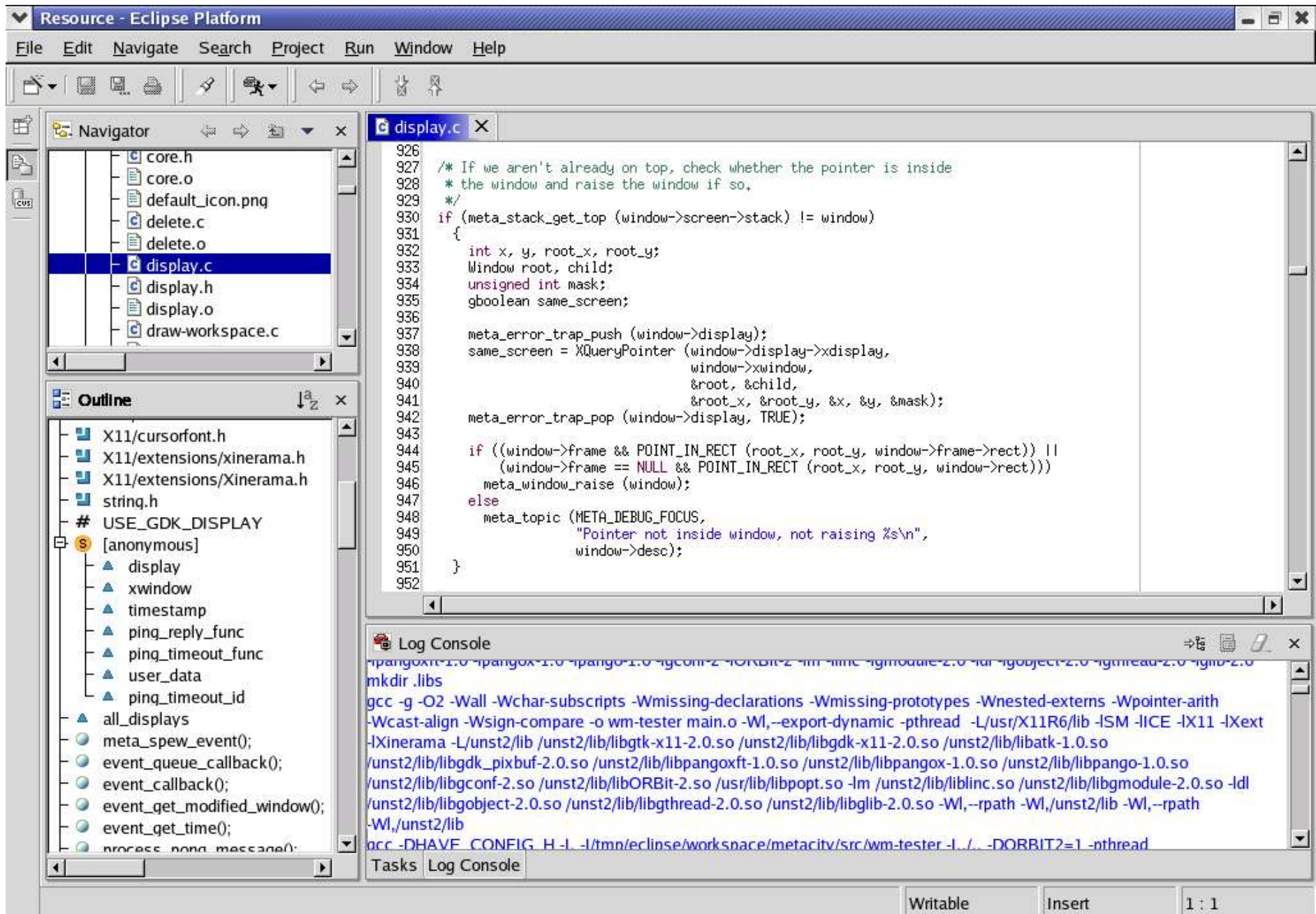

Source: <http://ometer.com/eclipse-shots/eclipse-metacity.png>

**What  
Software  
Tools?**



# GNU/Linux Software Tools

- GNU C Compiler (gcc)
- GNU Assembler (gas)
- GNU C++ compiler (g++)
- GNU Debugger (gdb)
- Data Display Debugger (ddd)
- Java SDK
- Python
- Tcl

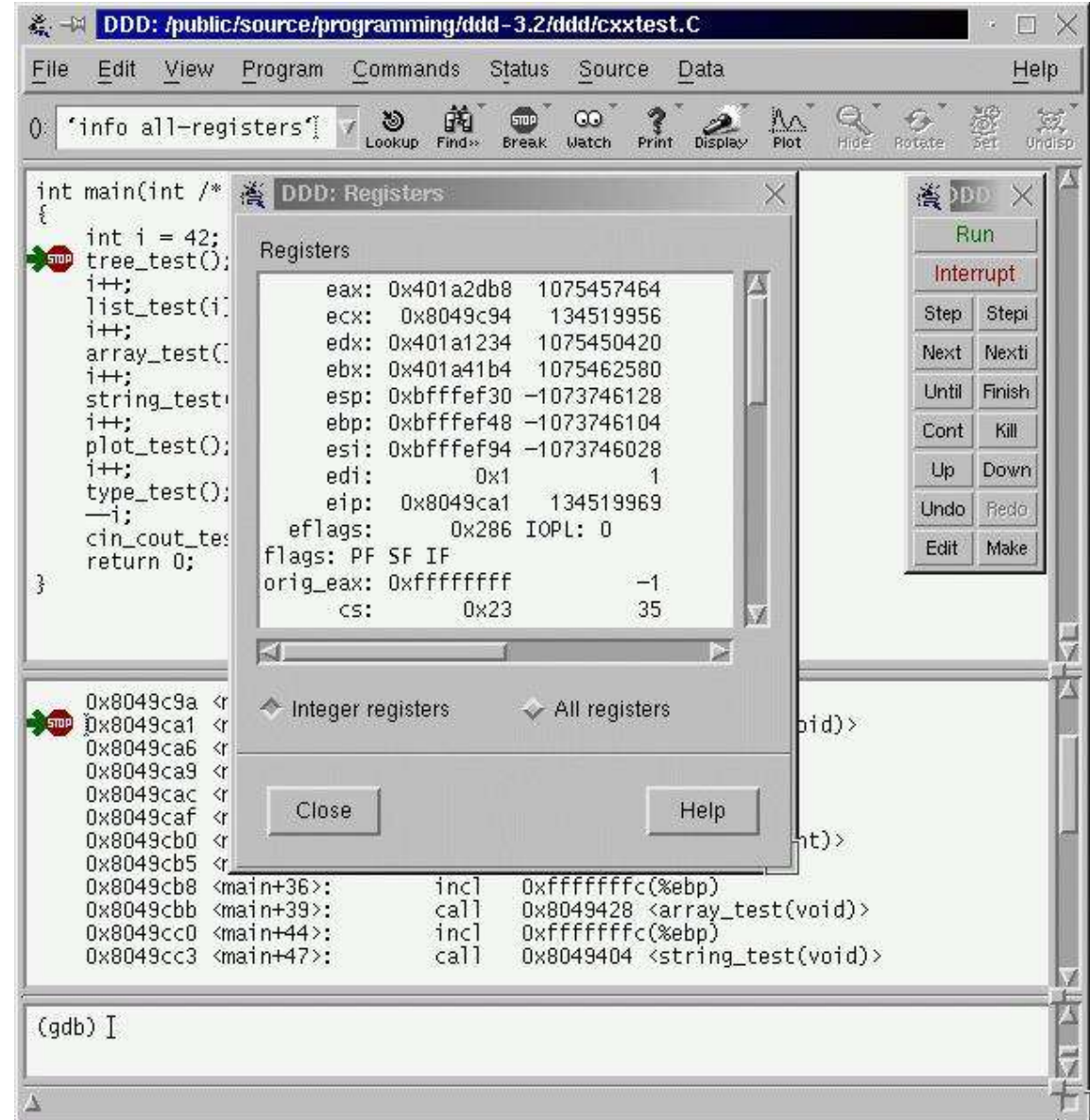

# Java with Eclipse

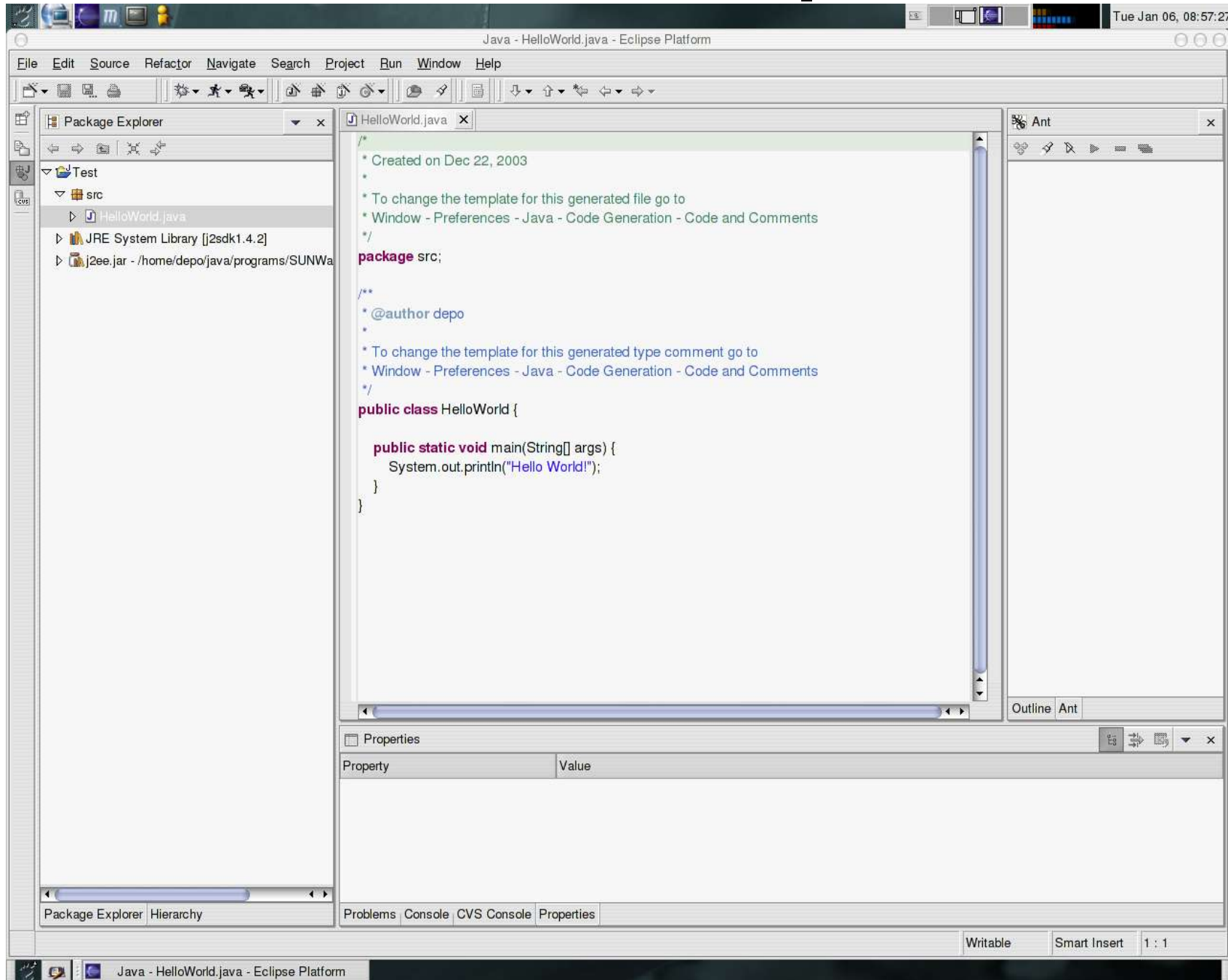

Source: [http://www.depeupleur.com/blog/TT\\_blog/archives/000011.html](http://www.depeupleur.com/blog/TT_blog/archives/000011.html)



# GNU/Linux Math Tools

- Scilab
- r-project
- pspp
- IT++
- GSL
- GNU Octave
- gnuplot
- LabPlot
- LaTeX

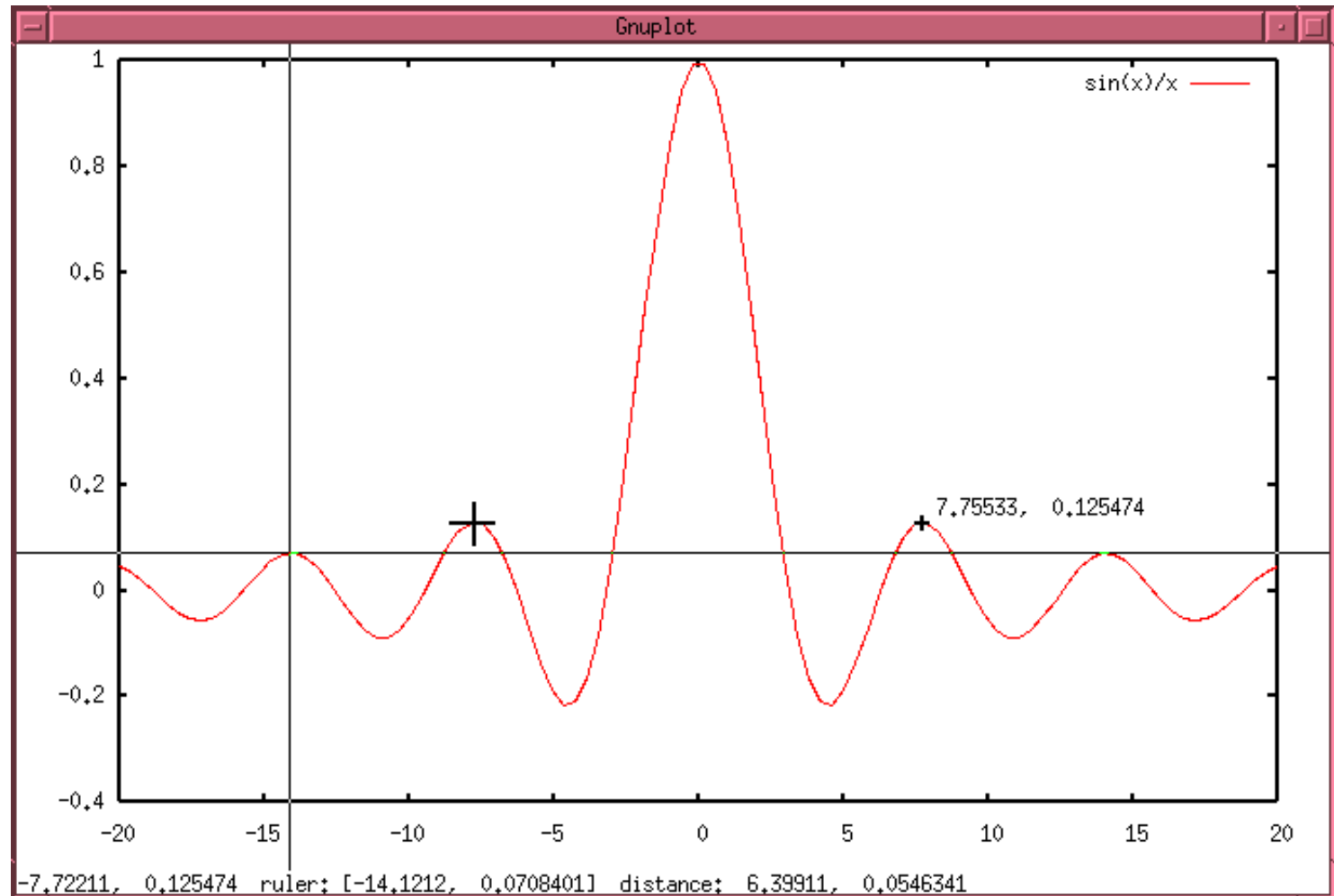

Source: <http://gnuplot.sourceforge.net/screenshots/figs/term-mouse-X11.png>



# r-project

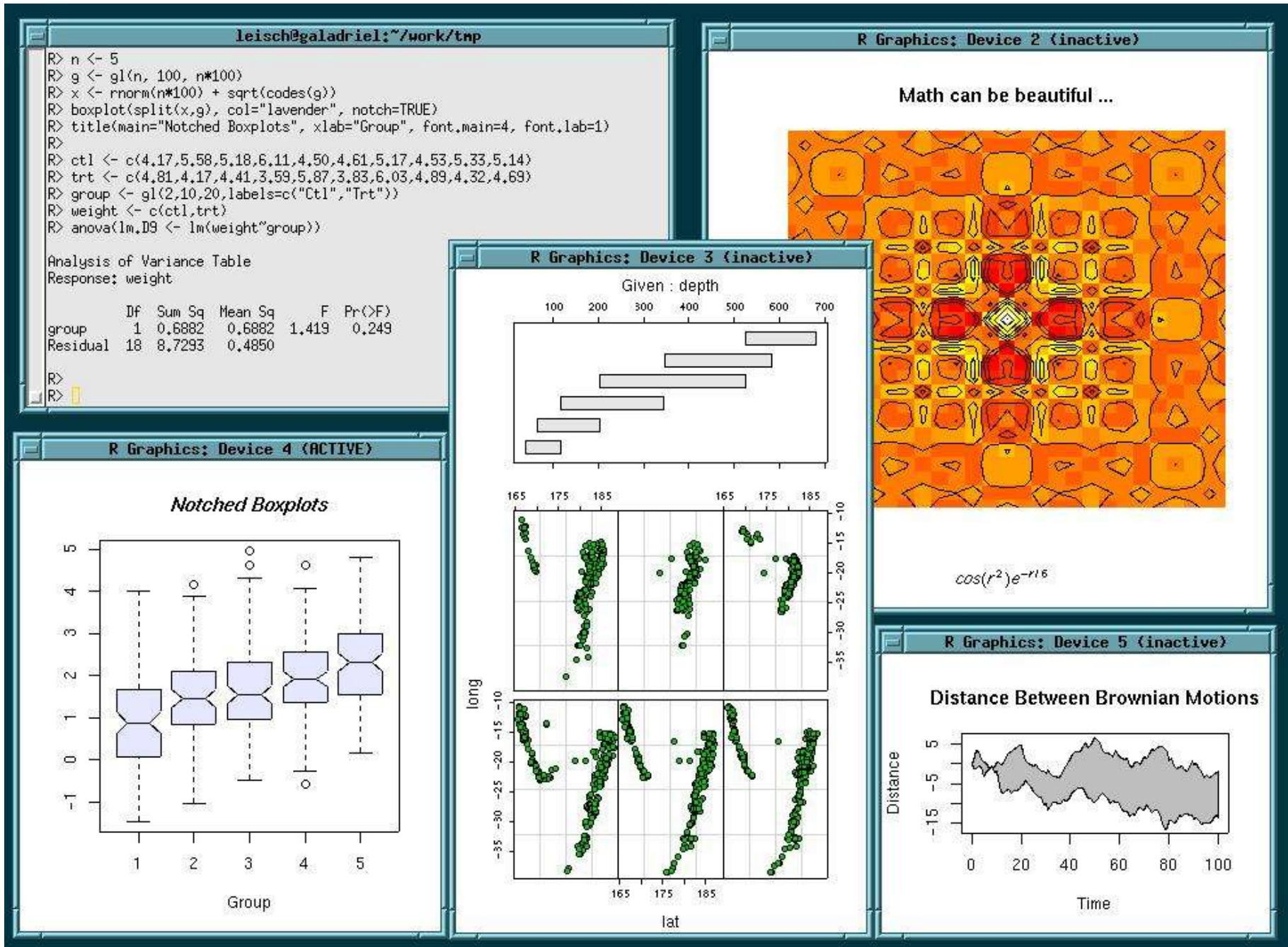



# GNU/Linux EDA Tools

- Alliance
- gEDA
- PCB Tool
- EE Tool
- TkGate
- XCircuit
- gerbv
- gputils
- vlsi

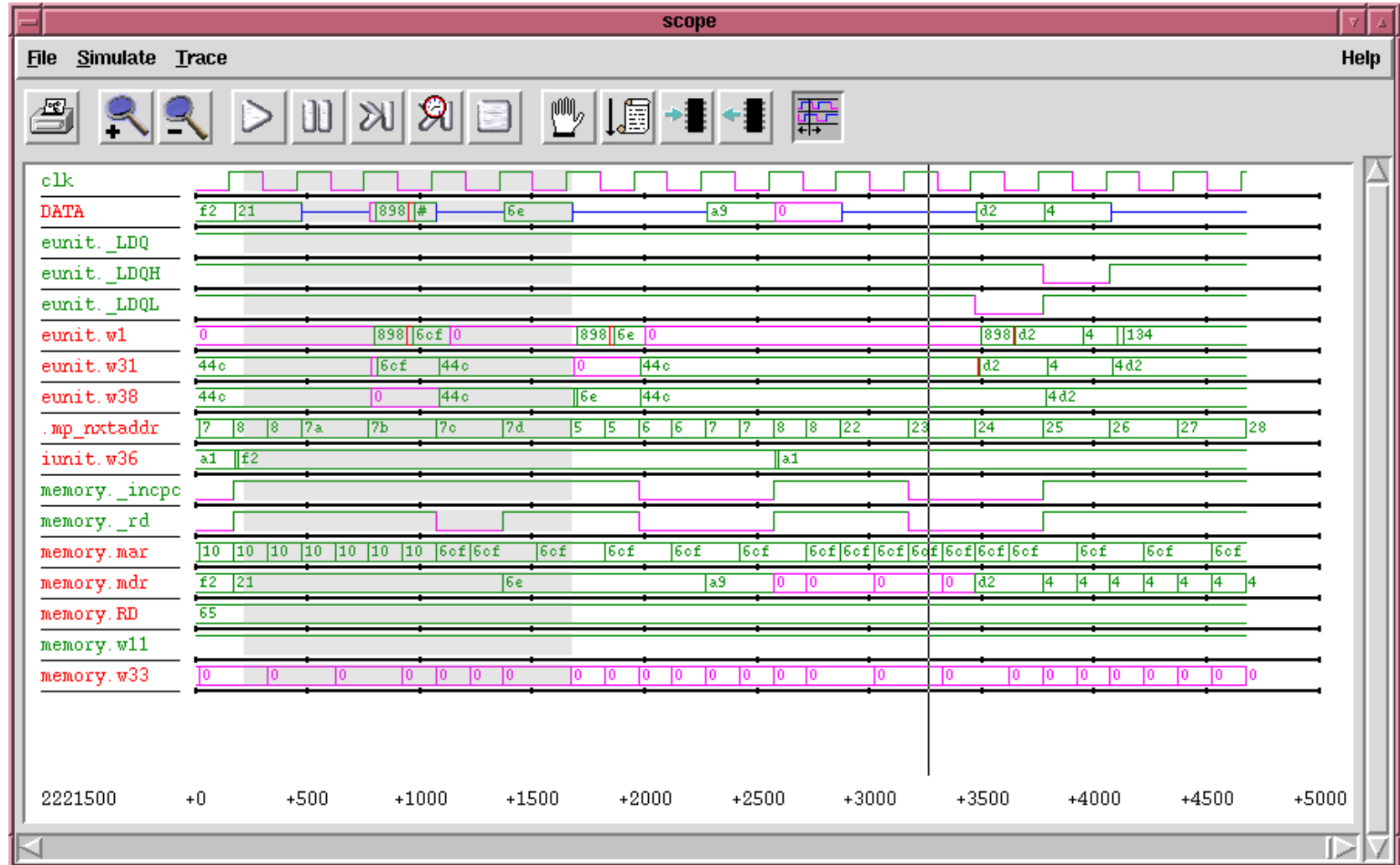

Source: <http://www.tkgate.org/fig/scopewin.gif>

# gEDA

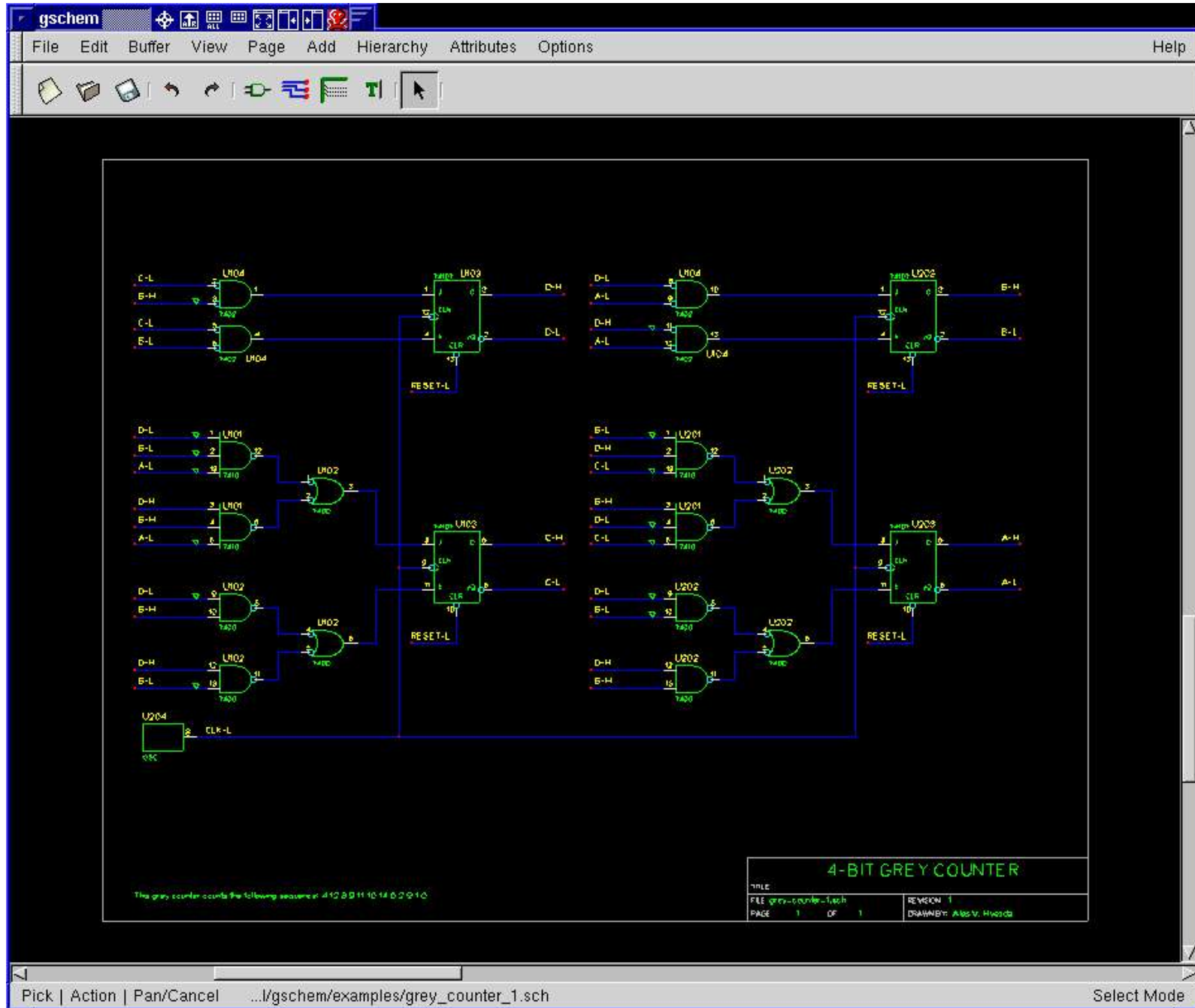

Source: <http://www.geda.seul.org/screenshots/screenshot-gschem1.png>

# PCB

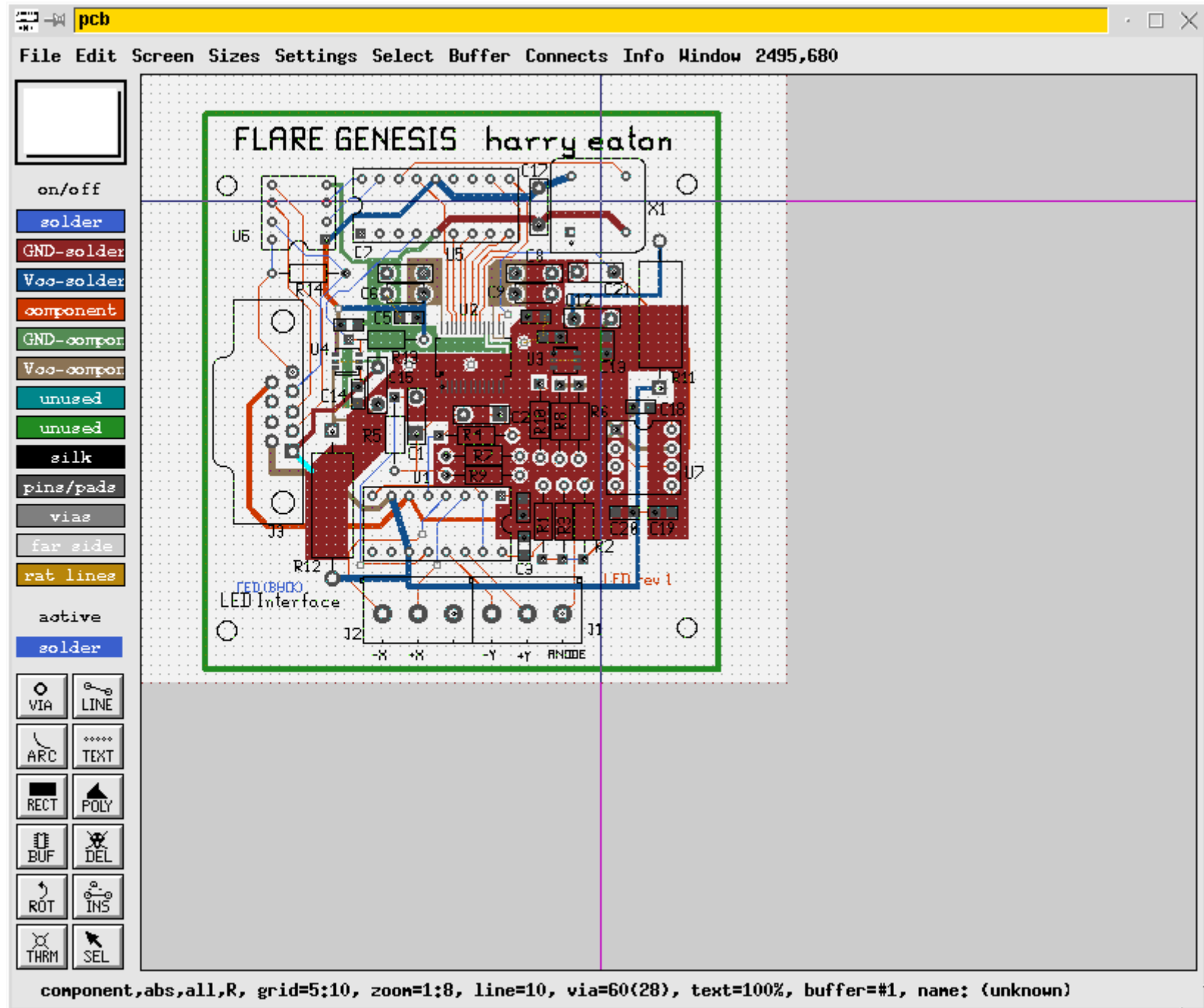

Source: [http://bach.ece.jhu.edu/~haceaton/pcb/pcb\\_screen.gif](http://bach.ece.jhu.edu/~haceaton/pcb/pcb_screen.gif)

# TkGate

test.v\* - TKGate 2.0

File Edit Tool Circuit Simulate Module Gate Make Help

Bits: 1 Technology: default

Modules

- main
- ALU
- REGS
- Unused

Edit Interface Simulate Critical Path

data\_in data\_select

func sa sb

reg\_out[7:0]

File: test.v\* Module: main

## Welcome to TkGate 2.0

Copyright (C) 1987-2004 by Jeffery P. Hansen  
TKGate comes with ABSOLUTELY NO WARRANTY; see 'Help...License' menu  
for license and warranty details. Report problems to [hansen@tkgate.org](mailto:hansen@tkgate.org)

Click on a link below to start using tkgate!

[Go to the tutorial](#)

[Edit a new circuit](#)

[See the documentation at http://www.tkgate.org](http://www.tkgate.org)

# Gerber Viewer

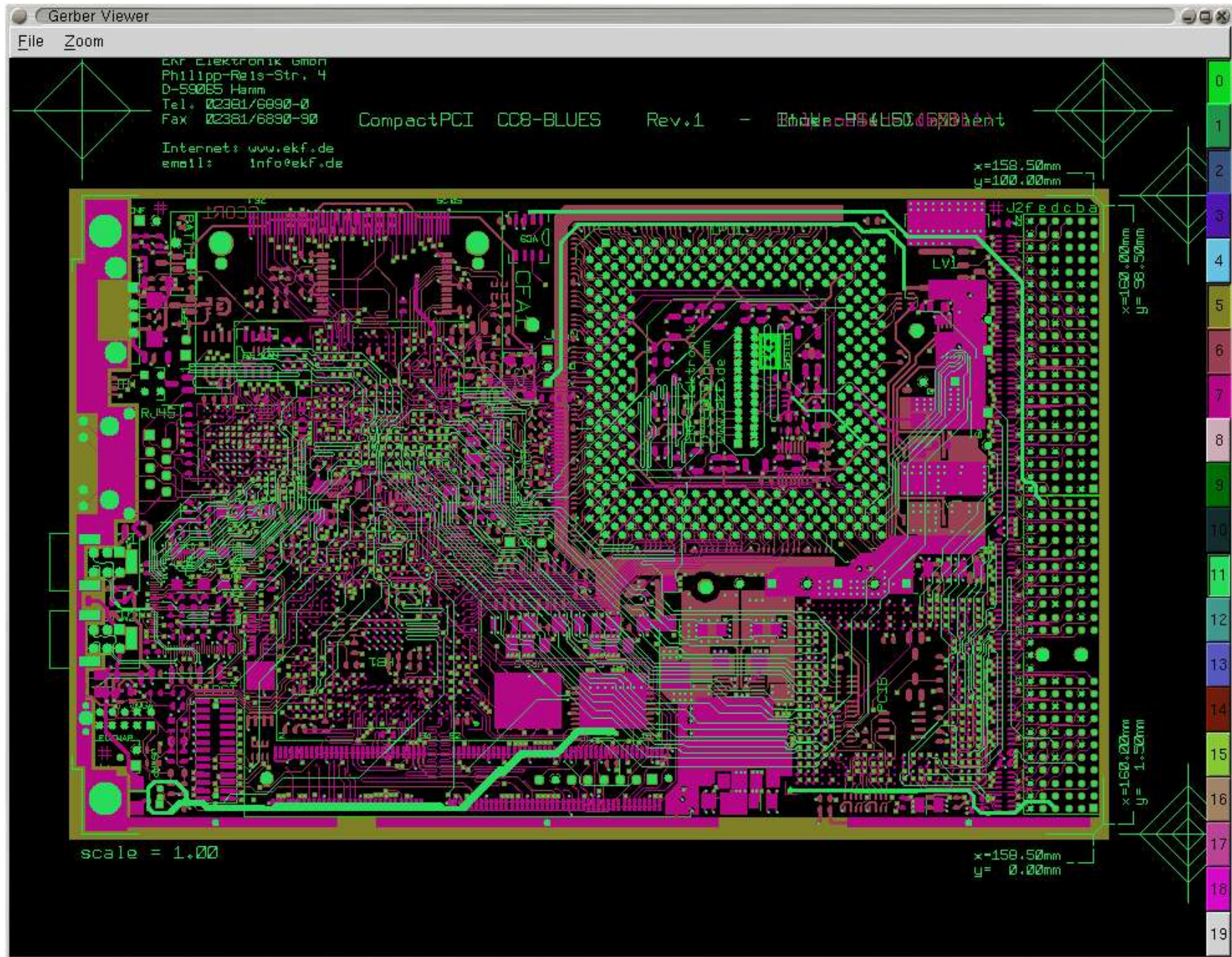

Source: <http://gerbv.sourceforge.net/screenshot2.png>

**What about  
Hardware?**



# GNU/Linux Simulators/Emulators

- **DOSBox**
- **Bochs**
- **xmame**
- **PearPC**
- **MESS**
- **MAMEoX**
- **gsim51**
- **qucs**



Source: <http://www.mess.org/messscrs.html>



# PearPC

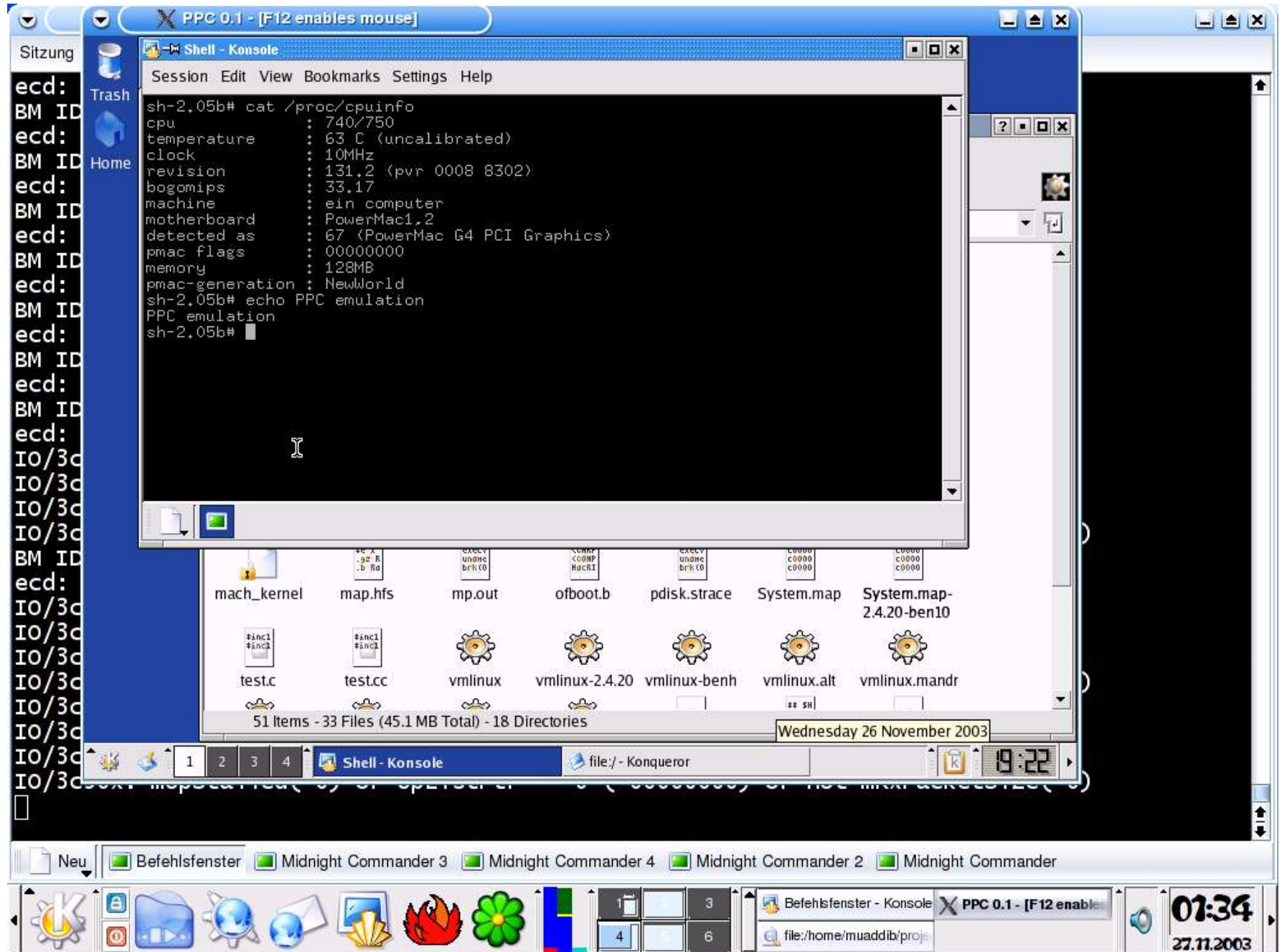

Source: <http://pearpc.sourceforge.net/screenshots/kde.png>

# qucs

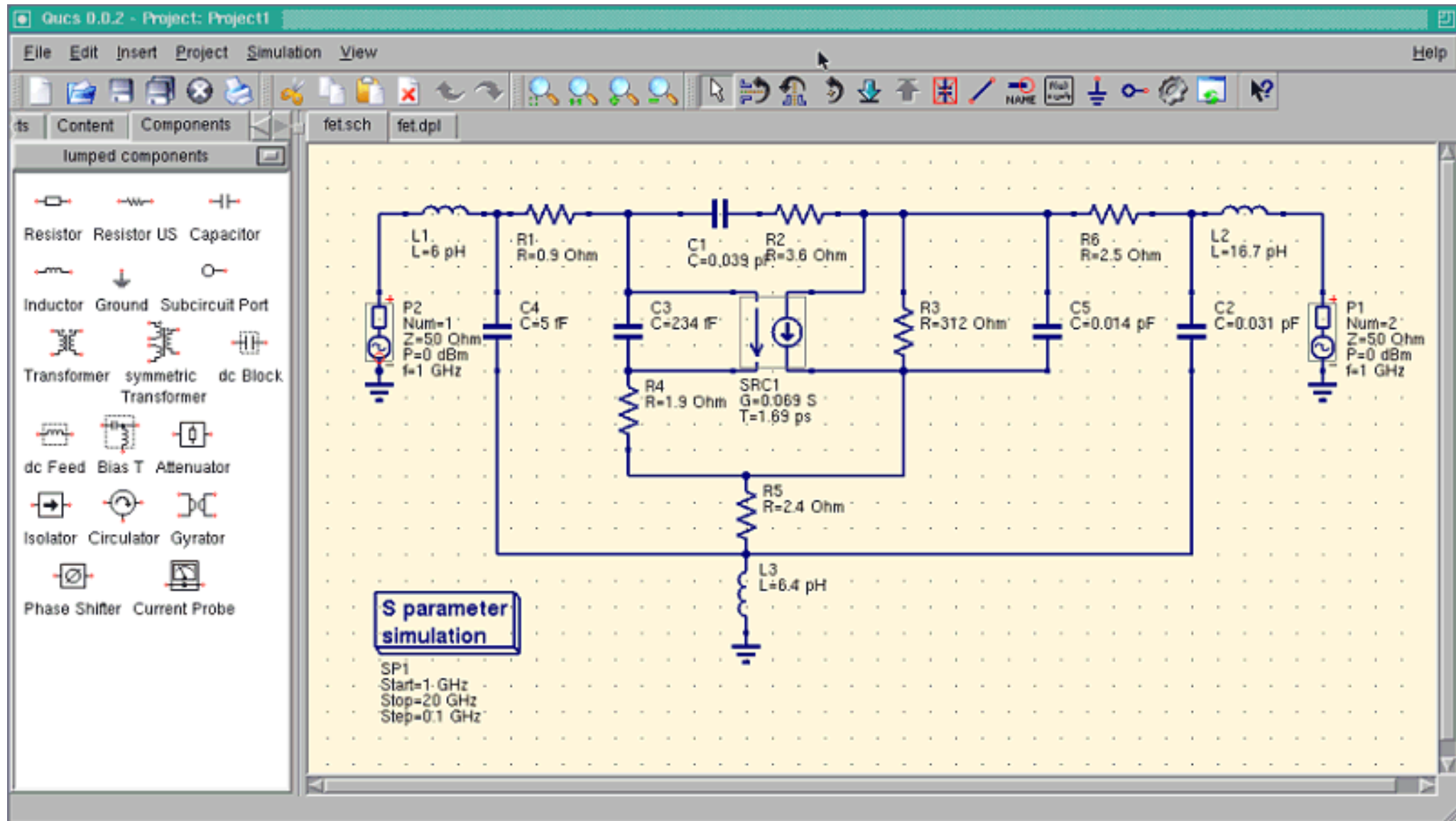

Source: <http://qucs.sourceforge.net/screenshots.html>

**I need tech  
support**

# GNU/Linux Tech Support

---

## Projects

- <http://sourceforge.net>
- <http://freshmeat.net>
- <http://savannah.gnu.org>

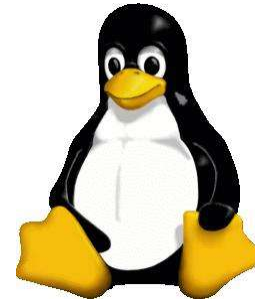

## Online Documentation

- <http://www.tldp.org/>
- <http://www.google.com/linux>
- <http://www.linux.org>
- [http://www.linuxforum.com/linux\\_sites.php](http://www.linuxforum.com/linux_sites.php)
- <http://www.kernelnewbies.org>





# GNU/Linux Tech Support

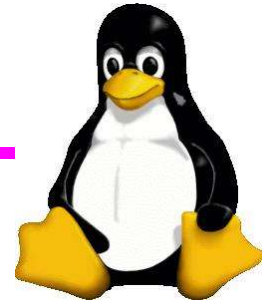

## Internet Relay Chat (IRC)

irc.freenode.net

- #c
- #asm
- #linux
- #redhat
- #suse
- #kernel
- #gentoo

### IRC Clients

- xchat
- irssi
- gaim

The screenshot shows the X-Chat IRC client window. The title bar reads "X-Chat [2.0.8]; mbuf @ niven.freenode.net / #gentoo (+thcPLf) #gentoo-overflow 20,7". The window has a menu bar with "X-Chat", "IRC", "Server", "Settings", "Window", and "Help". The main chat area shows a message from "s" with the text: "s break xorg 6.8 || 2004.2 minimal cd won't boot? bug 58821". Below this, a conversation ensues: "scrp" asks "- cos the resolv.conf is empty"; "razerboy" replies "yes, depends on if you have the wong lived like i had the other day and had to start from stager1 to change the architecture"; "lscd" asks "DJGummikuh: i suspect ext3 is the slowest; i don't have hard benchmarks [and a lot depends on your usages]"; "likewhoa" asks "anyone linux2.6header users?"; "Athas" replies "I don't get why people are so riled up about Emacs' resource usage. I mean, right now, Firefox and X combined, consume about 250mb, while Emacs hovers around 20."; "phox (~phox@phox.dk)" joins the channel; "roger55" asks "Statix: want to bet you didn't follow the instructions?". On the right side, there is a list of users: "32 ops, 894 tota", "roger55", "rphillips", "SeJo", "slarti'", "SpanKY", "spyderous", "swegener", "tavisio", "[pkh]", "[radon]", "[suller]", "[SV]KaI-EI", "[WAN]Glow", and "\Locutus\". At the bottom, there is a status bar with "FreeNode" and channel tabs for "#gentoo", "#c", "#asm", and "#kernel".

# GNU/Linux Tech Support

---

## Forums

- <http://www.linuxquestions.org>
- <http://www.linuxforum.com/forums/>
- Mailing lists
- Usenet and Newsgroups



## LUG

- <http://www.chennai.lug.org>

Linux Expo/Conferences

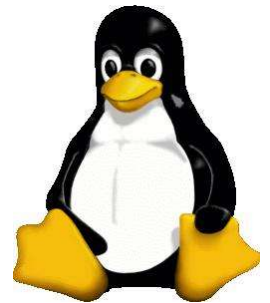

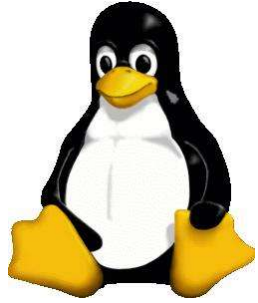

# Contact



- **N Shakthi Kannan**
- **E [shaks@shakthimaan.com](mailto:shaks@shakthimaan.com)**
- **IRC nickname “mbuf”**
- **[linuxforum.com](http://linuxforum.com) “x86processor”**
- **GNU/Linux Links**

**<http://www.shakthimaan.com> -> Links**



**Thank You**

